

NOTA: La tubería para la entrada de aire + salida ceniza, no está dibujada ya que depende del soplador a emplear

HOGAR CARBÓN

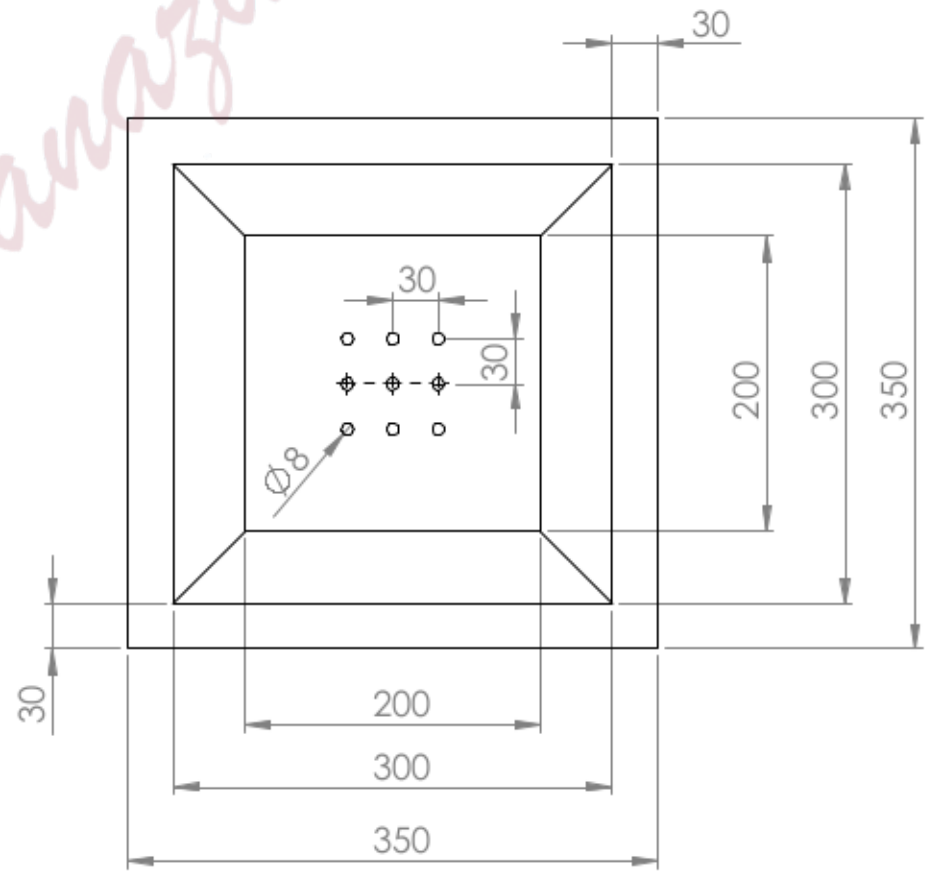

ESQUELETO FRAGUA (tubo 50x50mm)

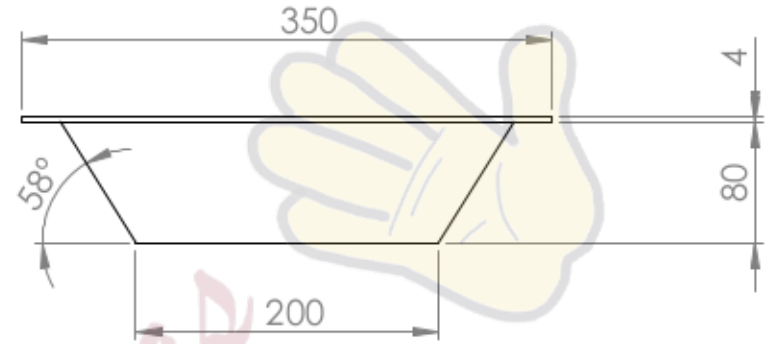
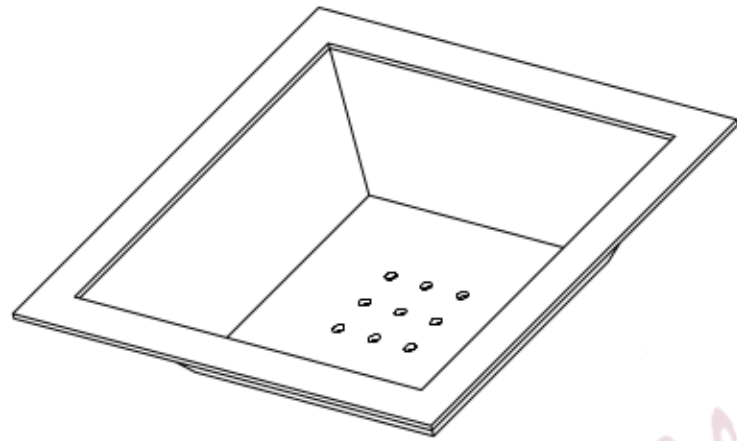
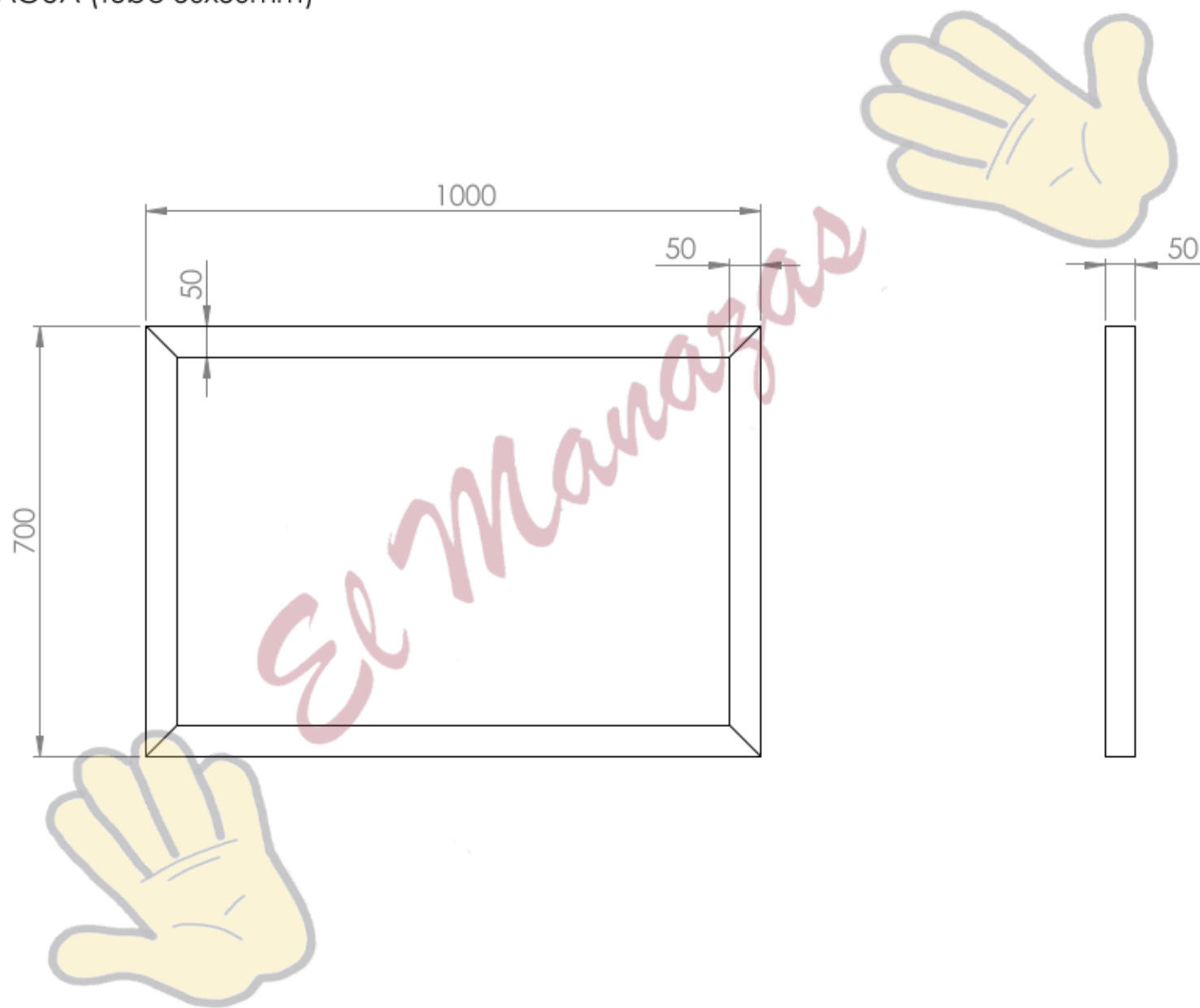

PERFIL SUPERIOR (perfil L 30x30x3)

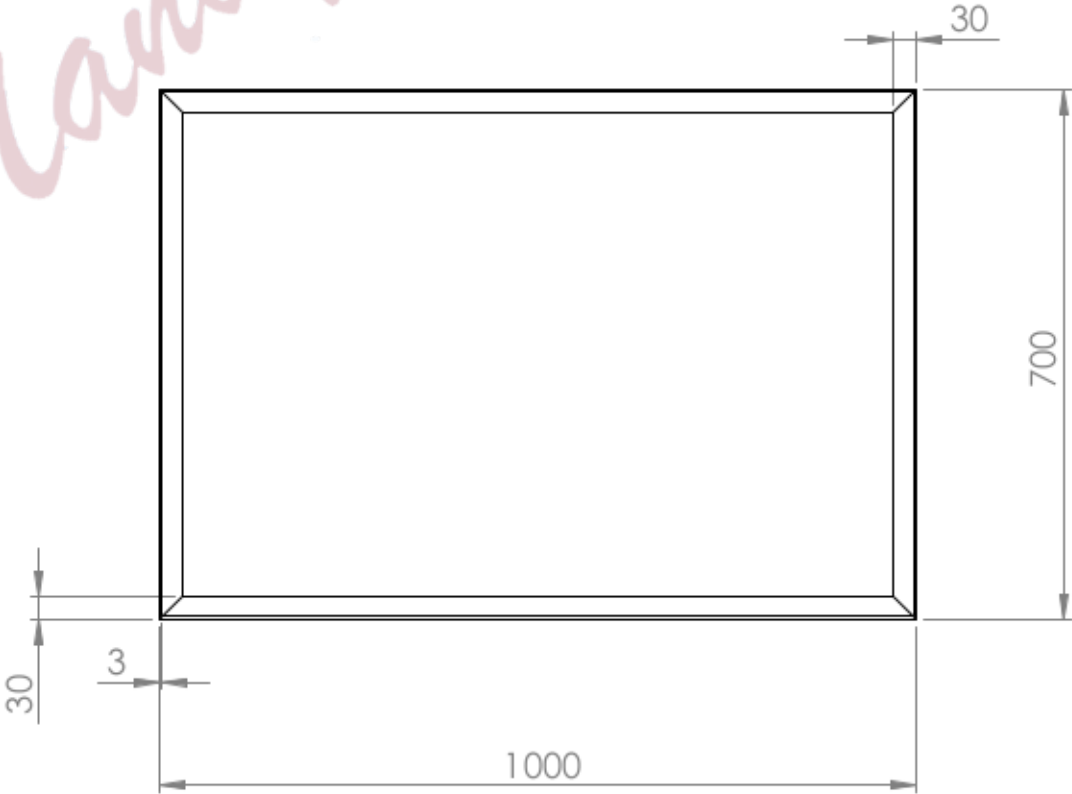
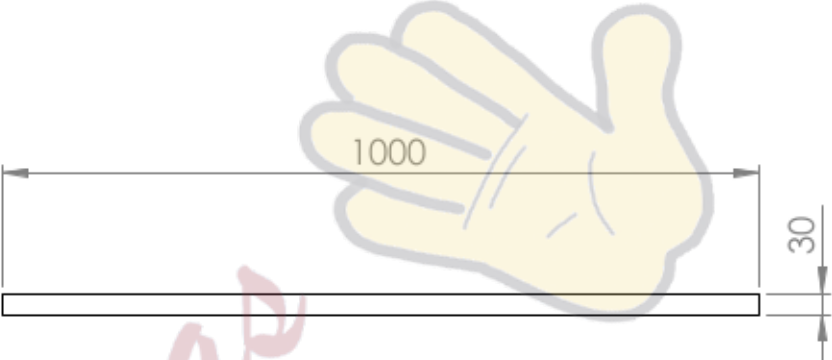
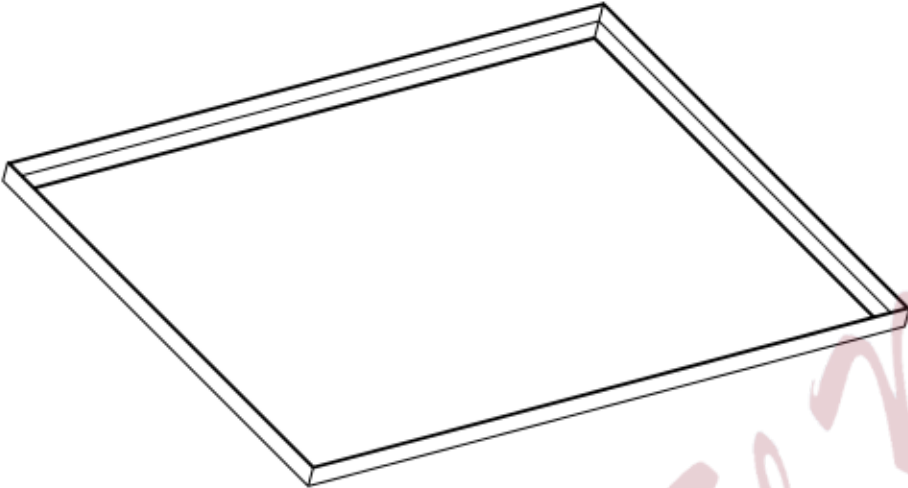

BASE FRAGUA

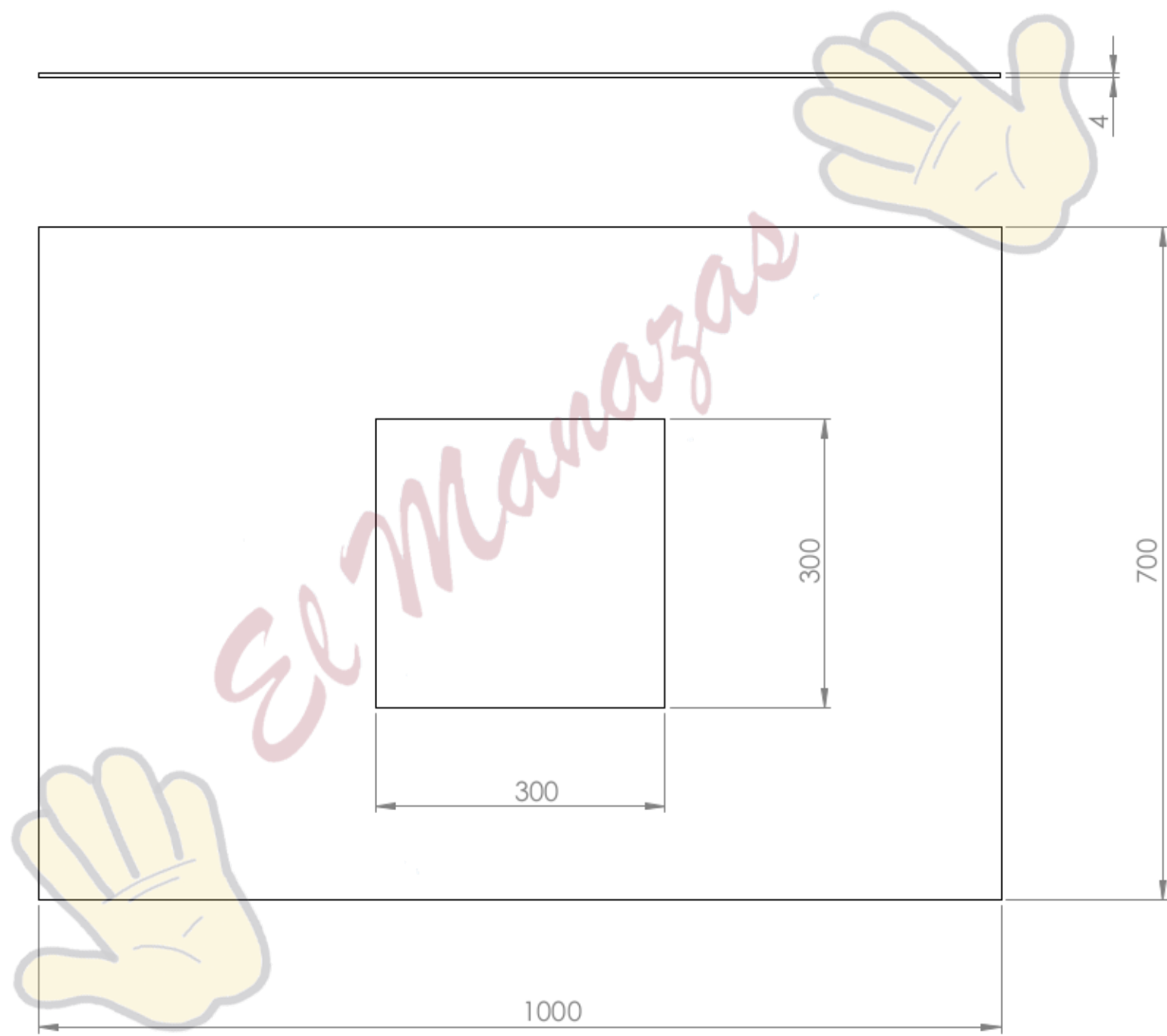

ASA PINZAS

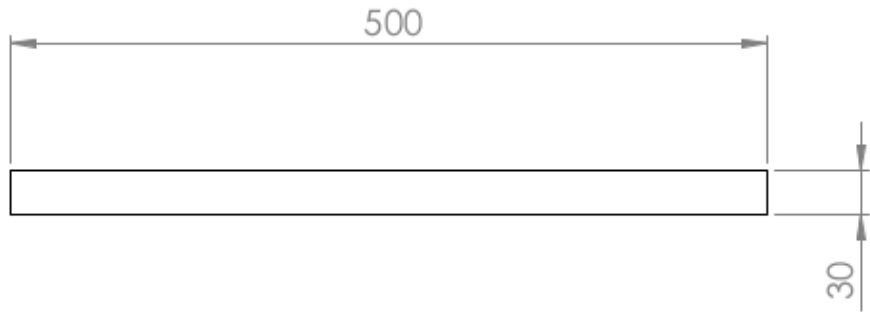

PATAS FRAGUA (TUBO 50X50X2)

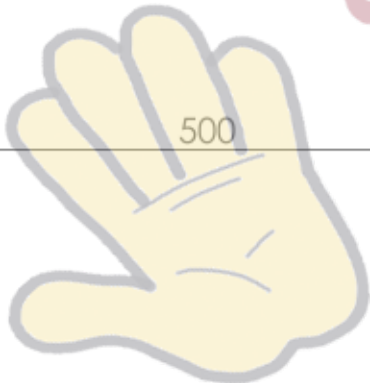
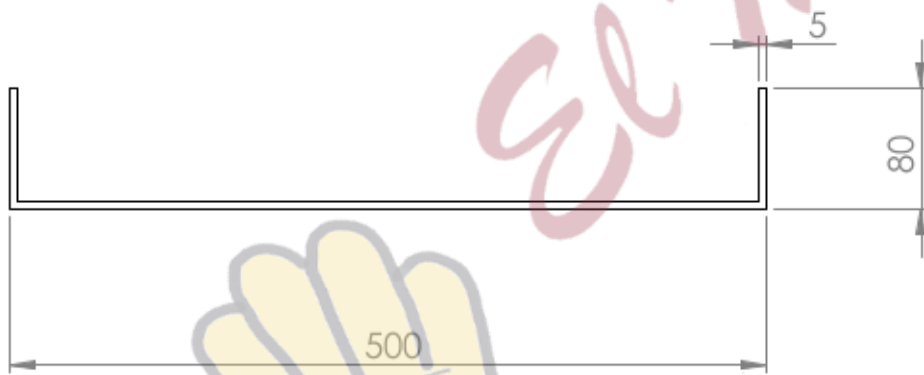
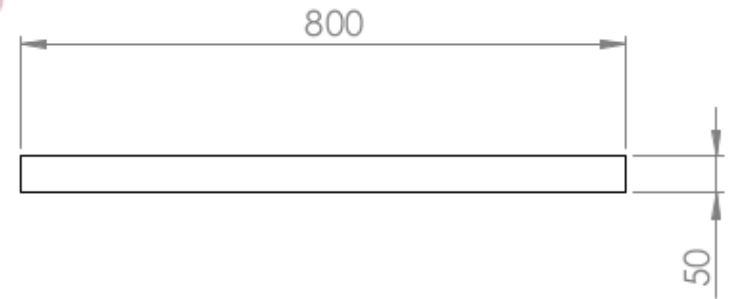

Se Manarzas